

PDF- VERSION ADJUSTED FROM THE BROCHURE



# TISSUE SOLUTIONS®

HOW TO PROTECT  
TISSUE MILLS FROM FIRE

FIRES IN THE TISSUE INDUSTRY  
FIREFLY SYSTEMS

YANKEE HOOD & DOCTOR BLADE PROTECTION

WEBSCAN™ & REEL-UP PROTECTION

REWINDER- , LOG SAW- & DUST FILTER PROTECTION

CONTACT US

# Spark causes storage hall fire

The police investigation of the fire last weekend at ... has concluded that the storage hall fire was caused by a technical fault, with no human error or act to blame. The police has named the cause as a spark from a steel part used in cleaning a drying cylinder, something which can happen in any papermaking operation and something which had occasionally happened in the past at ... Although all safety directions were followed, the police believe **a spark must have landed on a finished roll**, which was then stored in the parent-reel store where the fire later started. The spark was not visible and not to be expected, ... reports. Nevertheless, ... on inspection and they found the cause of the fire.

At Firefly we believe that loss due to fire can be avoided.

Let us tell you how Firefly's technology can save you a fortune...

### Fires in the Tissue industry

Many areas of a tissue mill are exposed to accumulation of dry, highly inflammable cellulose dust and fibre. The smallest outbreak of fire is extremely dangerous and can possibly spread throughout the entire mill. Small fires, for example at the Doctor Blade, can occur frequently and cause production downtime. If you calculate the amount of hours your production is stopped due to fire related problems, you will most likely find that fire in general is costing you a lot of money!



#### **In order to protect your process from fire:**

- You need a fast and reliable system of the highest technical standard
- You need a tailor-made system
- You need detection of potential hazards: i.e. sparks and hot particles occurring in your process

#### **Additionally, to ensure uninterrupted production:**

- You need an extinguishing method adapted to your process to minimise the risk of water damage

### We never generalise

For over 15 years, Firefly has specialised in creating tailor-made solutions for the tissue industry. Our competent staff has vast experience in the tissue industry and the highest technical skills necessary to design a safe fire prevention solution for your tissue mill. *We believe that you can, with a small investment, generate large payoff.*

**At Firefly we understand your business.**



## How we protect your mill

Our systems are designed to provide optimal safety against fire and minimal effect on machinery or production. From a range of unique patented products we combine a system depending on the design of your process. Firefly systems are designed to protect industrial processes and prevent damage to plants. Our products are:



### Detection

Detectors that indicate hot particles, sparks and flames in pneumatic or mechanical conveying systems

Detectors that indicate flames in open areas



### Extinguishing

Using full-cone water spray

Using water mist

Using mechanical diversion, isolation, steam or gas

### Control

Control unit for system monitoring and process control

### Services

Installation and Commissioning

On-site service of installed systems

### Tissue Solutions®

With Firefly Tissue Solutions® we offer protection of both the tissue machine and the converting process:

- Yankee Hood protection
- Doctor Blade protection
- WebScan™
- Reel-up protection
- Rewinder protection
- Log Saw protection
- Dust filter protection



**Our systems are designed to effectively protect your mill against fire.**

## YANKEE HOOD & DOCTOR BLADE PROTECTION

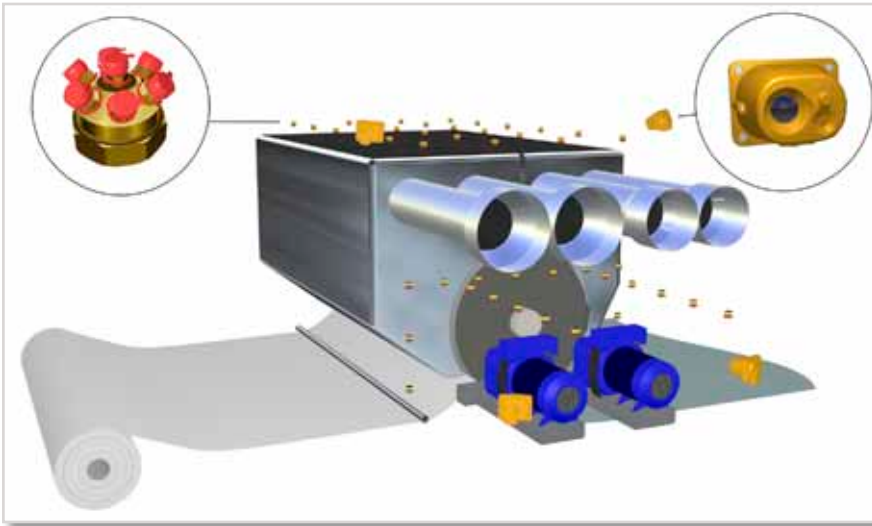

### Yankee Hood - The problems

As the area around the dry end of the Yankee dryer usually is dusty, a small smouldering fire can easily be spread by the rotation of the Yankee cylinder. As a result, ignition sources can be scattered to an even larger area. Once the fire has got a grip, particularly on the drive side of the tissue machine, the fire becomes not only dangerous but also difficult to extinguish without contributing to additional costly downtime. Conventional extinguishing methods generally require massive amounts of water to extinguish.

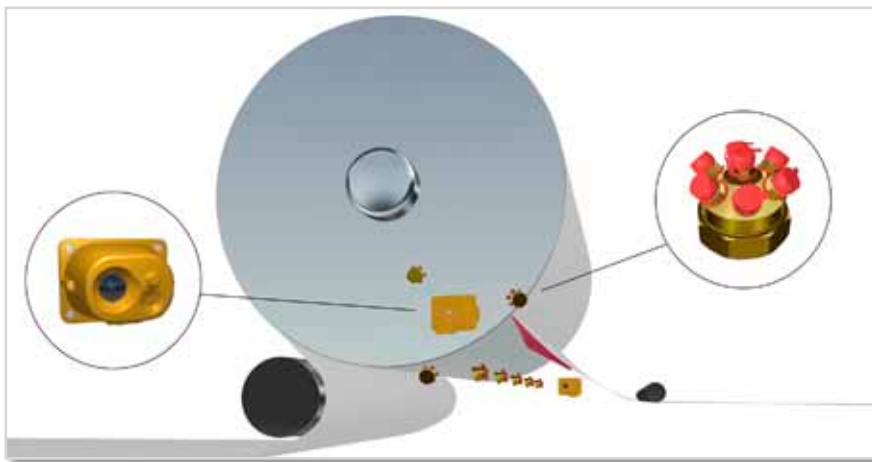

### Doctor Blade - The problems

A smouldering fire due to friction or sparks generated at the Doctor Blade is very common. This can be spread in the dusty area around the Doctor Blade. Even smaller fires can cause costly downtime.

### Flame detection – avoid false alarms!

The area around the Yankee Hood contains many different disturbances that can affect conventional flame detectors. The unique OAD (Open Area Detector) is a two-channel UV/IR detector, used for flame detection around the Doctor Blade and Yankee Hood. By combining IR and the UV wavelength, the detector will efficiently recognise flames but discriminate other energy sources such as lamps, sunlight and even arc welding. Firefly's Yankee Hood & Doctor Blade protection consists of extremely quick flame detection in combination with water mist extinguishing. Simultaneously, the mill's operators are given an alarm of the situation.



### Harmless extinguishing

When using water mist on hot metal surfaces or flames, the water vaporises into steam and this steam effectively quenches the fire. Firefly water mist has therefore a specific droplet size especially designed for extinguishing in these conditions. If the droplets are too small, they will be swept away by the thermal air flow. If they are too big, the risk for rapid cooling and structural damages of the tissue machine increases. *Firefly's philosophy is that extinguishing itself should not cause problems.* Our water mist extinguishing is a safe and efficient extinguishing with a minimum effect on your production.

#### The facts about water mist

By Factory Mutual Research

Cools the fire area and blocking the heat radiation

Cooling is accomplished due to the greater surface area presented by the quasi-gas created by water mist systems, and the blocking of radiant heat by the many microscopic droplets.

Displacing the oxygen

The atomized droplets are drawn to the base of the fire and flash instantaneously to steam, expanding in volume by 1,700 times, thereby displacing oxygen required for combustion.



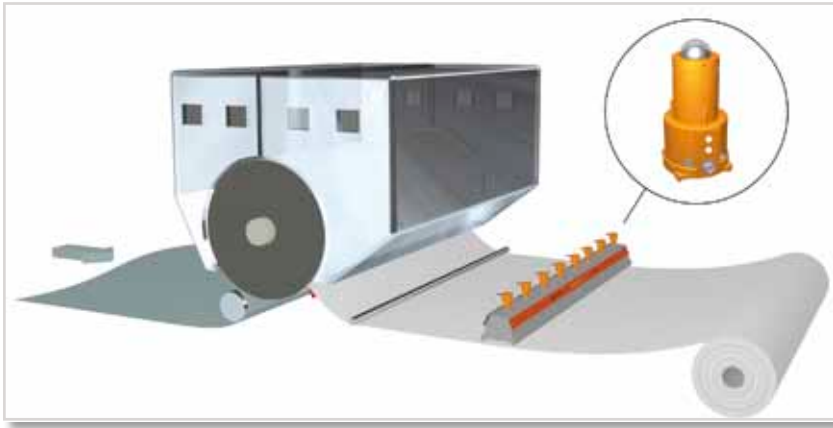

**Hot spots**

Imagine friction at the Doctor blade or smouldering particles from the Yankee Dryer. This can create glowing hot spots within the tissue sheet that can rapidly be enclosed and insulated within the parent roll. Unsuspected, the contaminated roll is then transported to the warehouse. It can take hours or even days but finally this contaminated parent roll can burst into flames. *Suddenly, a minor problem at the doctor blade has become a major problem in the warehouse.*

**Alarm enables quarantine**

To prevent fire in stored tissue rolls, Firefly has developed WebScan™. The WebScan™ system consists of detectors mounted above the tissue sheet, between the Yankee dryer and Reel-up. Heat radiation emitted by dangerous ignition sources on the sheet are detected. Within milliseconds after finding a hot spot on the sheet, an alarm is provided by the control unit. The alarm will enable operators to remove the contaminated roll to a safe quarantine area for further inspection and disposal or re-pulping.



**Unique technology**

The WebScan™ (WD) detectors used in the system are especially designed for the tissue industry. A WD detector indicates hot spots, glows and sparks from 250°C (480°F) on the tissue sheet. As each detector in the system is addressable separately, the system can provide the location of the ignition source along the width of the sheet. This information can then be used by the mill's control system. The WD detectors utilise Firefly Self Diagnostics (FSD technology), confirming sensitivity as well as internal temperature and humidity. As some tissue machines are quite hot at the dry end and wash downs are common, FSD ensures the function of WebScan™.

**Standard**

In 2005, SCA decided to use WebScan™ fire prevention technology from Firefly AB as standard in all its European-based tissue plants. SCA's based the decision on the strong focus and persistent belief in loss prevention, as this safeguards the health of SCA's employees, the security of its plants and enhances the bottom line. Since then, an increasing number of other tissue plants worldwide have followed SCA and realised the value of investing in fire prevention solutions.

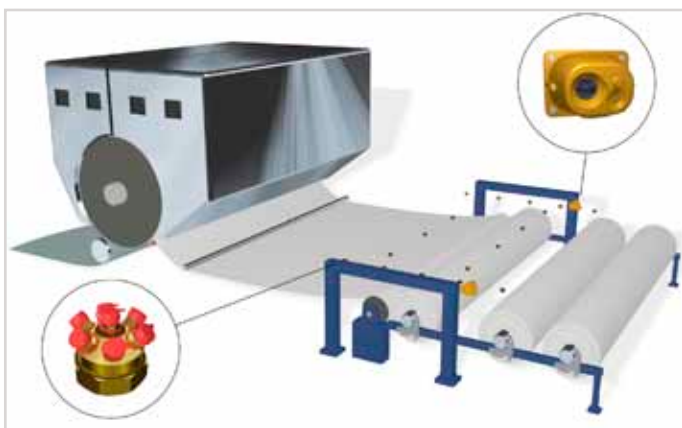

**REEL-UP PROTECTION**

**Reel-up - the problems**

The Reel-up operation generates a lot of dry dust that accumulates on frames and other parts in this area. Furthermore, shreds of paper from the tissue roll often end up around the axes of the Reel-up and can cause frictional heat that can ignite.

**Reel-up protection**

Firefly offers detection of flames with OAD (Open Area Detector) for the Reel-up area. Effective extinguishing with water mist will quickly put out the fire with minimal effect on the Reel-up process.

## Rewinder – the problems

The Rewinder generates a lot of dry dust that accumulates on frames and parts in this area. Furthermore, shreds of paper from the tissue roll often end up around the axes and can cause frictional heat that can ignite and cause a fire.

## Rewinder protection

Firefly's Rewinder protection solution will easily detect flames and effectively extinguish the fire. Equipped with OAD (Open Area Detector) on each side of the Rewinder and water mist nozzles, flames can easily be detected and extinguished.

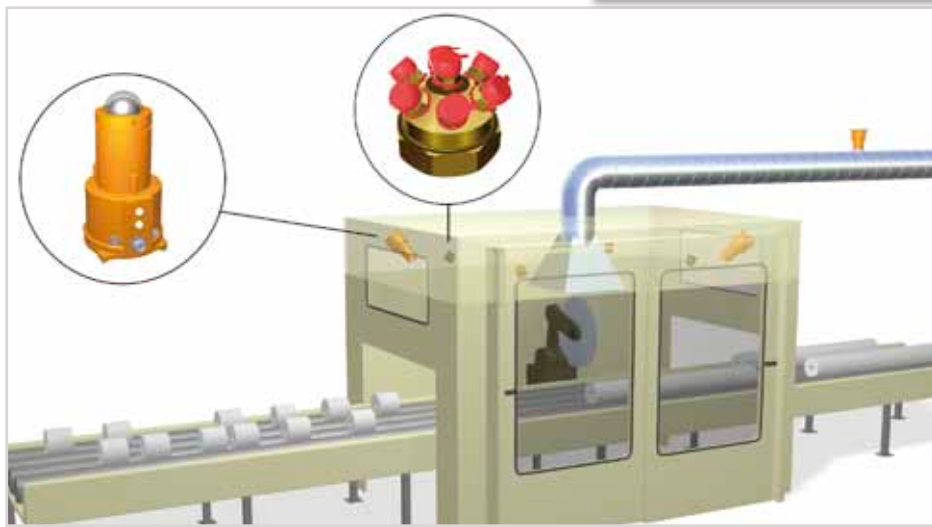
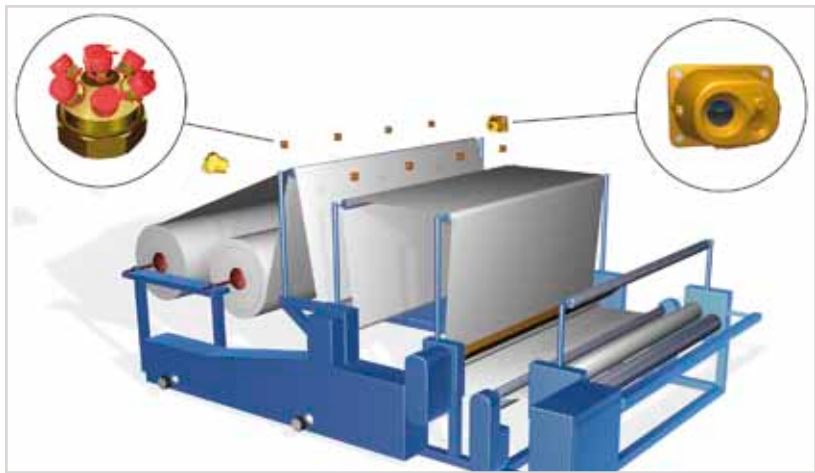

## Log saw - the problems

Fires in Log saw enclosures are unfortunately common and costly. Friction or sparks generated during the sharpening of the saw blade can ignite the dust inside the Log saw enclosure. As Log saw enclosures generally are dusty, ignition can easily cause equipment damage and production downtime.



## Log saw protection – don't give a fire time to grow!

Firefly's Log saw protection consists of extremely quick and automatic flame detection in combination with water mist extinguishing. With fast and automatic flame detection inside the enclosure, loss of production and equipment can be minimised. Water mist, compared to alternative extinguishing solutions such as CO2 or powder, *is a non-invasive extinguishing method that will effectively extinguish with a minimum effect on your production*



## Dust filter system – the problems

Ignition sources such as sparks and hot particles generated in the paper mill and the converting process can create fires and dust explosions in the dust filter system. It is therefore vital to protect also this part of your process!

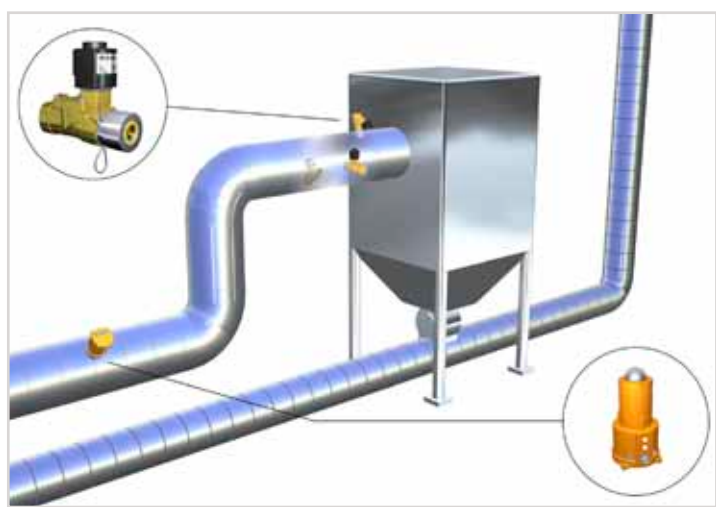

## Dust filter protection

Firefly's dust filter protection system consists of detectors that indicate sparks and hot particles with a temperature over 400°C (750°F), which is the ignition temperature for cellulose dust according to NFPA (National Fire Protection Association). A water spray extinguishing zone is normally installed to eliminate these dangerous particles.

**Return on investment of Tissue Solutions® can be achieved already with one fire incident.**



Firefly users sleep well at night

SCA

P&G

Virtisú

Georgia-Pacific

Kimberly Clark

Productos Familia S.A.

## Firefly – Keeps you in production

Firefly is a Swedish company with more than 35 years of experience in the process industry. We deliver complete systems to protect your tissue mill against fires and dust explosions.

With unique solutions, quick delivery and excellent service, Firefly has become the natural choice for the tissue industry worldwide.

Contact us and we will tell you more about how we can provide you with the best safety for your process!



Ph +46 8 449 25 00 | Fax +46 8 449 25 01 | [info@firefly.se](mailto:info@firefly.se) | [www.firefly.se](http://www.firefly.se)



CONTACT US



Nothing contained herein is intended to serve as a warranty or guarantee relating to the products displayed.

Please visit our website to view our limited warranty for all product related claims and limited warranties.

